



Ventilation unit with heat and moisture recovery



www.xvent.cz

suitable for apartments and smaller family houses
universal installation location
heat and moisture recovery exchanger
possibility to connect external preheater
easy installation

...The Xflat unit is focused on maximum utility value for use in apartment buildings. Thanks to its dimensions and MultiPlacing design, the unit can be installed in 6 different positions and in really small installation spaces.

The unit excels in low weight and low height (only 13kg and 180mm)

Thanks to the unit's classification in energy class A+. **Xflat** complies with subsidy programs.

CO2 and RH sensor can be connected to the unit.

The control also offers the possibility of expansion for remote control and connection to your **smart home**.

The possibility of connecting an external **pre-heater** directly to the unit - thanks to this, pre-heating works only in cases where the unit is in danger of freezing.

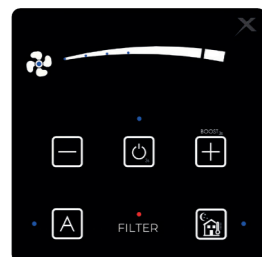

Wired control is used to control the air output and other functions of unit.

The body of the unit is made from black EPP (expanded polypropylene).

The front EPP cover is removable when needed for major service or cleaning.

The connection sockets are at an angle of 45° and thus allow rigid or flexible ducting without crossing the contour of the unit.

Filters with high capacity - filter class M5 (alternatively F7).

Accessible control - easy connection of necessary accessories.

Two types of heat recovery exchangers. **Heat recovery or heat and moisture recovery (enthalpy recovery).**

„MULTIPLACING“ system

The condensate drain is ready in each position for easier installation. By default, they are all blinded so you only need to cut one and that's it.

CEILING INSTALLATION

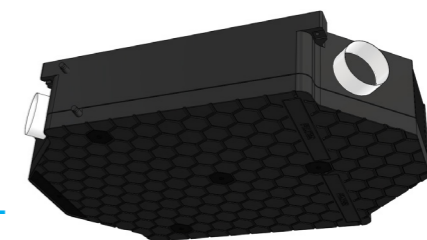

WALL HORIZONTAL INSTALLATION (Only version with enthalpy exchanger)

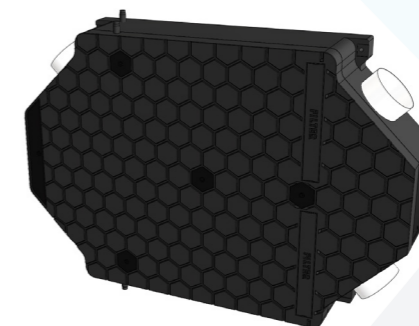

WALL VERTICAL INSTALLATION

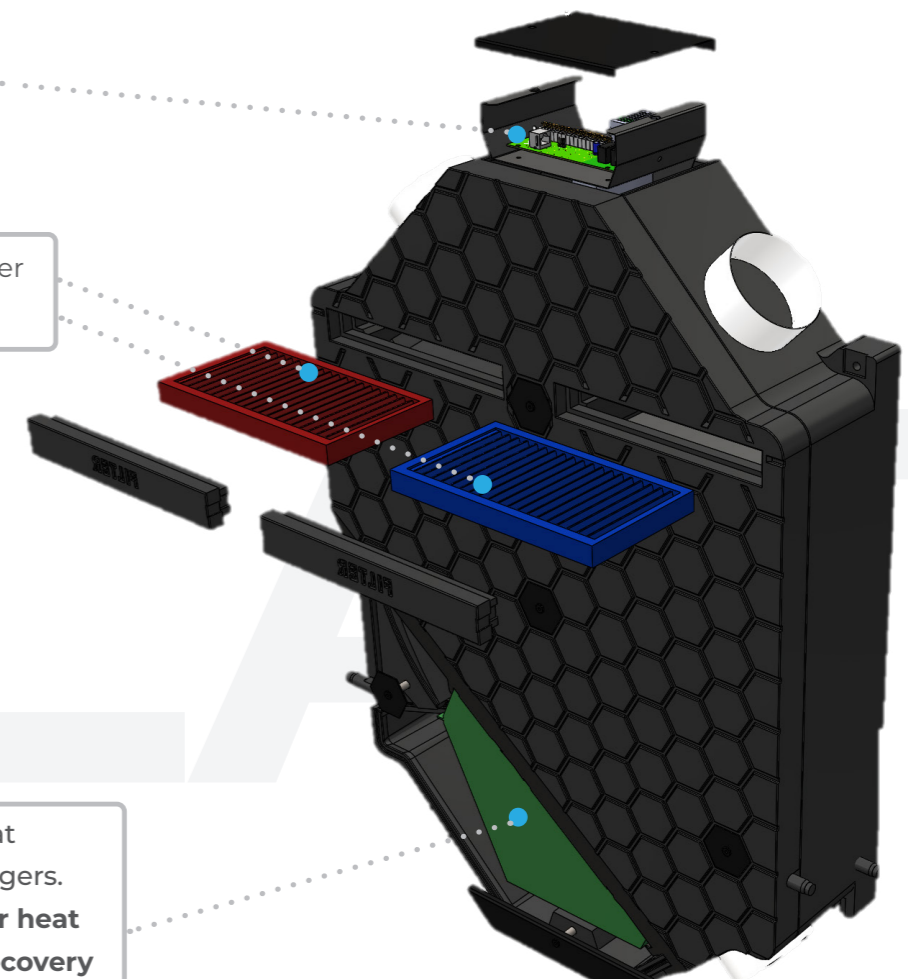



...description of the unit and its feature...

Central unit **Xflat** with heat and humidity recovery. With its air output of 150 m³/h, it is very suitable for ventilation of apartments with a living area of up to 70 m². The design of the unit allows it to be installed in any position on the wall or ceiling. Thanks to its minimum height, it can be mounted on ceilings of normal height without interfering. During its development, great attention was paid to reliable condensate drainage in any position. The equipment of the Xflat unit is such that it meets all the requirements for equipment in this category. The Xflat unit has a body made of premium Extruded Polypropylene (EPP). This makes it light and makes installation very easy.

Description of air flow



Coding of unit Xflat

XF1-015-EC S0HRXAS-0A0													
XF1		015		EC		S0		HR		XAS		-0A0	
XF1		015		EC		S0		HR		X		A	
unit Xflat - mark 1		airflow 150m ³ /h		fan with EC motor		without heater		heat recovery		without preheater		standart color	
								ER		B		0	
								heat and moisture recovery		LEFT		design type	
								S		A		0	
								standard control		RIGHT (standard)		reserve	
								F		X		0	
								standard control		without preheater		0	

Frequently asked questions / Answers

Decentral vs. central ventilation...

Decentral ventilation is mechanical ventilation for one room only. **Central ventilation** is mechanical ventilation of more rooms by once device.

Central ventilation is provided by units with bigger dimensions than units for decentral ventilation, since these has to supply higher air volume. Units for central ventilations are usually located in the technical room where they are not annoying the users by high noise level and they are not blocking any space. Central ventilation systems require ducting for supply and extract air, which are often difficult to place in the way to do not disturb. Central ducting systems require cleaning every year, which is complicated. Cost investment of the installation of ducting and theirs covers are usually in the same level as the purchase price of the ventilation unit. Another aspect is regulation and controlling of these systems in order to achieve minimum operation costs and distribution of the air to there where is needed. The advantage is, that suction and exhaust does not have to be located on the outside wall and if so, there are always only two openings.

Decentral units are used for ventilation of one room only. Theirs dimensions vary from very small ones located in to the wall, to bigger ones with dimensions similar to smaller radiator. These units ventilate only selected rooms and when needed. Theirs advantage is, that these units can be operated according to sensors of quality of the air (Air Quality sensors -AQS), typically by CO2 sensor or relative humidity sensor. Thanks to the sensors the unit ventilates only when the concentration of pollution in the air is above set level – this means "ON DEMAND". This ensure, that the energy consumption during ventilation is at minimum level, about 35% lower than ventilation without sensors. More powerful units can supply in to the room bigger air volume of the air in case of need than central units and thus can ventilate the room faster and better.

It is necessary to consider more suitable solution for each specific project.



What is heat recovery...

Heat recovery generally means backwards usage of the energy. In the case ventilation we talk about heat recovery or eventually about moisture regeneration. Quantity of energy to be saved is expressed by efficiency shown in percentage points and such a value represent quantity of the heat/moisture, what is the unit able to gain from the extracted(exhausted) air and transfer it to supplied (fresh) air. Higher efficiency value means better. This is valid for heat recovery with efficiency up to 85%, because the heat recovery with higher efficiency has trouble with freezing condensate in the exchanger. This fact seriously limits the heat recovery during winter time.

Important fact is, that ventilation with heat recovery saves up to 85% of the heating costs in comparison with ventilation by windows.

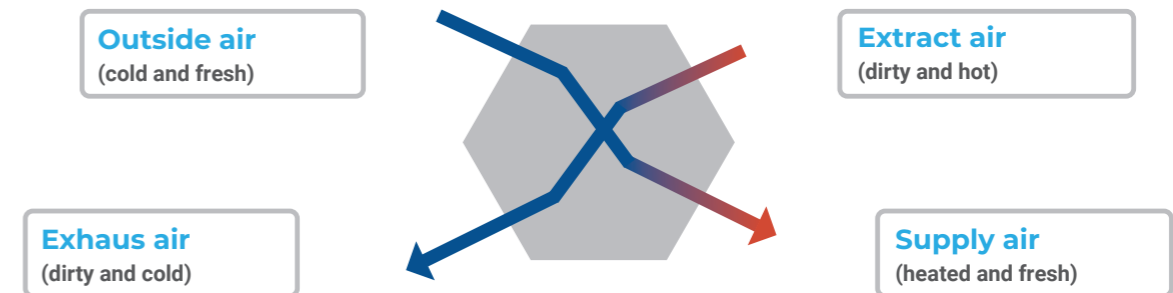

What means enthalpic regeneration...

Enthalpic regeneration (ERV) means backwards gaining of the moisture from the extract air. The supplied air is so dry in the winter, that it can reduce the indoor relative humidity in the air below 20%. Such a low relative humidity cause drying-off the skin, mucous membrane and wood-made furniture and floors. Dry mucous membrane makes breathing less comfortable and cause respiratory diseases. Dehydration of the skin makes wrinkles and the drying-off the wood can damage furniture or floors. Ideal relative humidity inside should be around 50%. The solution is usage of **Enthalpic Recovery Exchanger** (Xvent recommends).

It is important to know that enthalpy heat exchangers always also recover heat.

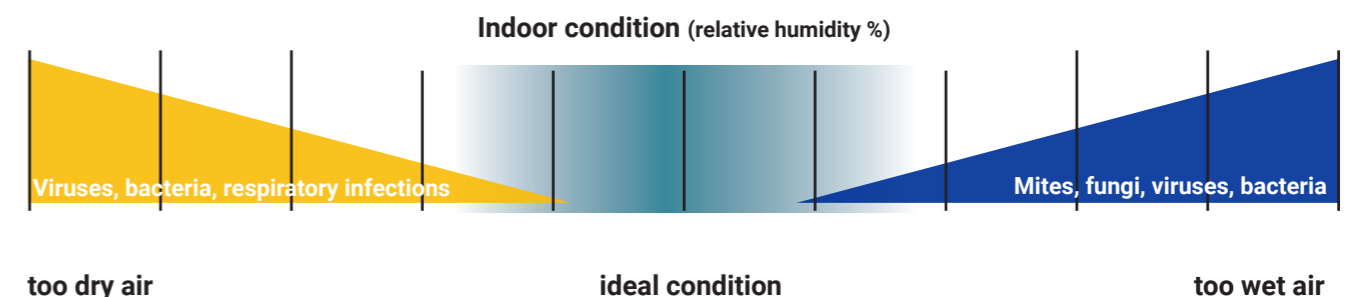

How to choose right size of the unit...

One of the mains parameters of the unit is the air volume which is the unit able to supply in to the room. Value which is usually used for choice, is quantity of the air at one square meter of the floor space. **Manufactures usually used 25m³/h at 20m²**. This is half quantity which ensure healthy climate. For the most cases are better to use quantity of the air need at quantity of the people inside the room. Typical value is **25m³/h/person**.

It is important to choose higher value of both methods in specific case anyway.

Why is mechanical ventilation needed...

Ventilation by windows is in many cases enough (residential areas, alone houses close to the forest), but does not ensure the energy savings (heat in the winter, cold during summer). But if there is noise outside, pollen, annoying smell or freezing conditions, the ventilation by window is not the best solution. Even thought in the summer, if the room is equipped by air conditioner, is the opening the windows not suitable. In all cases mentioned above is the mechanical ventilation senseful solution. If the unit is equipped by heat recovery and/or moisture regeneration, the energy savings reach 85%, which will have to be supplied by heating or by cooling device otherwise.

It is important to consider if the priority is price or health.

What means „multiplacing system“

Xflat is a unique unit in that it can be installed in almost any position. It is equipped with three condensate outlets as standard. After installation, the end of the plastic part of the „condensate drain“ is cut off - only in the place where the condensate will drain (according to the selected installation position)

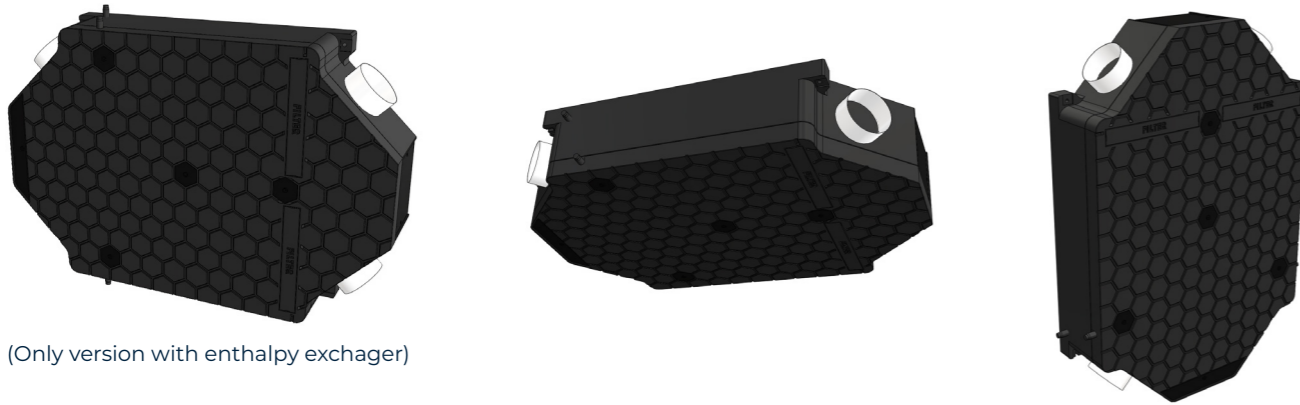

(Only version with enthalpy exchanger)

Why sensors (air quality sensors)...

Sensors enable automatic operation of the unit. The unit operates only, when the inside quality of the air is worse than requested. When fulfilling the air quality request, such a solution generate only minimum ventilation costs in the real operations! This also means lower operation costs and faster paid back of the investment to ventilation unit purchase. Xflat enables connection of **CO2 sensor, RH sensor and radon sensor**. **It is important to consider, if the more important are operation costs, or purchase investment.**

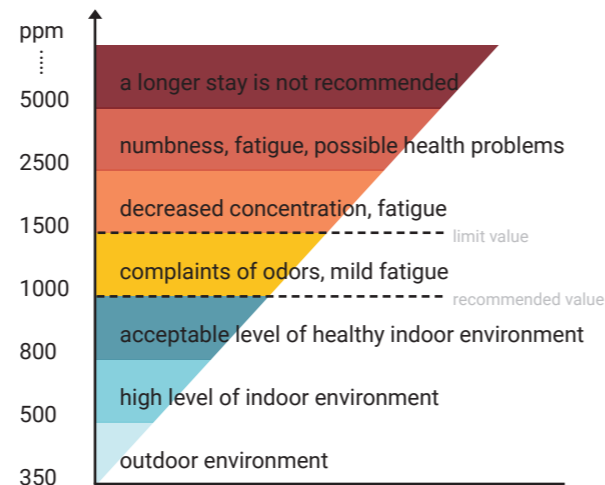

What are the operation costs...

Operation costs are generated by heating costs, costs to operate the fans and by maintenance and service costs. Heating costs are lower about 85% in comparison with ventilation by windows for the same time period. Operation costs of the fans are thanks to the EC fans 1 EUR/month when considering average usage four hours a day every day. Costs of filter replacement are around 10 EUR/month when replaced twice a year.

How complicated is the installation...

Installation of the unit is simplified, that handyman can install it by him self. Installation does not require any specialist. Because the unit is very light, installation is possible in one. The mains connection cable is already removed from the unit. Retrofitting and connection of accessories is carried out in the control box.

How difficult is the maintenance...

The Xflat is designed to be maintenance free. Only thing needs to be under the control is filter clogging. Good condition of the filters ensures smooth operation and stable high level heat recovery and moisture regeneration. Clogged filter is signal by flashing diode „filter“ on the control panel. In such case is necessary to follow the operation manual. The front cover comes to remove and by opening two plugins with inscription „FILTER“ is possible to access and replace these filters by new clean ones. The replacement of the filters to be confirmed by pushing the RESET button and that's it.

It can not be easier.

What is the difference between electronic and mechanical bypass...

Summer bypass - During the colder nights of the summer, in addition to the normal ventilation of the windows, it is also possible to use forced ventilation with the bypass function. Otherwise, it pays to use a ventilation system with heat recovery. This bypass directs the exhaust air around the heat exchanger (see figure), thus preventing the „cooler“ supply air from being heated by the warm exhaust air.

Elektronický bypass - Electronic bypass - there is no physical bypass of the recuperator, but only the exhaust fan is switched off. The supply fan pushes the air through the recuperator, but it is not heated by the exhaust air.

+ Better price, greater thermal efficiency, fewer mechanical parts

■ No air is discharged during bypass switching (the object is slightly overpressured)

Mechanický bypass - there is a physical bypass channel with a flap that opens the bypass channel and closes the recuperation section at the same time.

+ Equal pressure ventilation

■ Lower thermal efficiency, higher price, more mechanical parts

Recovery logic

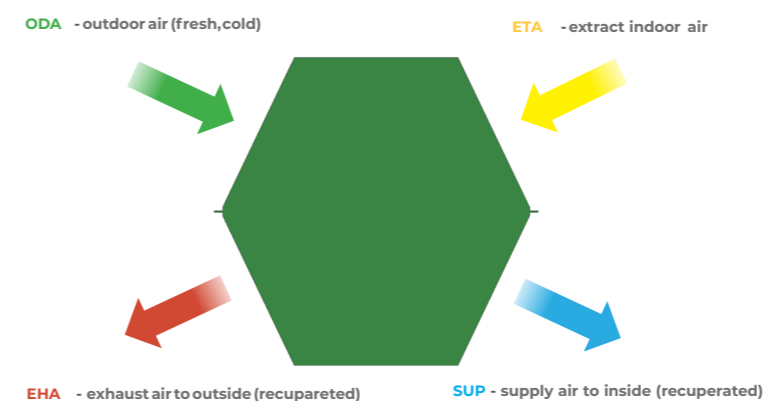

Bypass logic (fresh air bypasses the recuperation part)

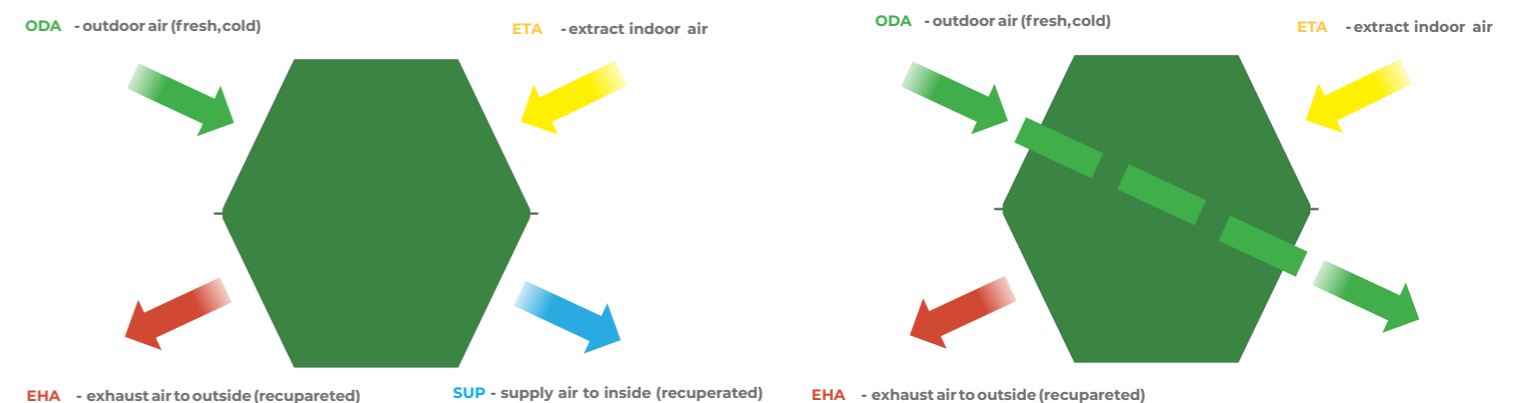

Control description Xflat

AUTOMAT/MANUAL

By pressing the button, you come to the manual mode – ventilation is manually controlled by user, out-puts from the AQS sensors are ignored. By pushing the button once again you can active automatic mode – ventilation on demand based on AQS sensors (if connected)

FILTERS CLOGGING

Indication of clogged filter is activated by timer, roughly after 6 month operations (only if the units ventilate). Indication is signaled by red diode flashing.

NIGHT COOLING (bypass)

Activate the night cooling function by pressing the button. The night cooling is used for cooling down the room in the summer by cold night air. This function is active for 8h from activation. Intensity of the supplied air is possible to change during function run. Once the function is over the values comes back to the previous setting.

BOOST MODE

By pressing the button for 3sec the intensive ventilation will start for 30sec period. Shall you wish to turn off this regime within 10 minutes, press the button for 3 sec once again and the unit comes to the setting used before. Boost time running you are able to set in customer menu (30sec - 20min)

Control panel description

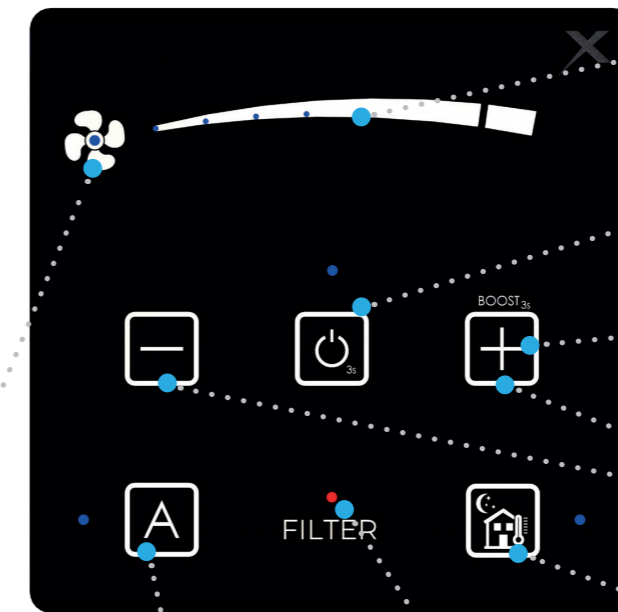

Indicator of air flow setting

ON/OFF

BOOST mode - 3s holding of button

Air flow setting

Night cooling activation

Fan status diode

Automat / manual switching

Filter clogging diode

UNBALANCING FLOW

In customer menu its possible to unbalanced flow of fans (0-35%). The exhaust fan will have less power than the supply fan.

CHILDREN'S LOCK

Activated by pressing the summer mode button for 6 seconds.

ANTIFREEZE PROTECTION

The unit is equipped with an anti-freeze sensor located in the recuperator. If the temperature drops below the set limit, the unit starts the antifreeze protection - fan balancing. If the unit is equipped with an external preheater, which is connected to the unit control, the preheating is started first and if it is insufficient, the fan balancing is started.

Technical data Xflat

VENTILATION AND HEATING UNIT WITH HEAT AND HUMIDITY RECOVERY

Type		Xflat-150-heat and moisture recovery efficiency								
		XF1-15-ECS0HRXAS-0A0				XF1-15-ECS0ERXAS-0A0				
Type of recovery exchanger		HRV (heat recovery)				ERV (enthalpy recovery)				
		Flow (m3/h)	HR efficiency (%)	Current(A)	Power input (W)	Flow (m3/h)	HR efficiency (%)	ER efficiency (%)	Current(A)	Power input (W)
AirFlow - setting	1.	35	92	0,2	9	30	80,2	61,2	0,2	9
	2.	50	90,6	0,2	13	45	79,1	59,1	0,2	12
	3.	70	88,3	0,2	22	65	77,8	57,5	0,3	20
	4.	90	86,5	0,3	33	80	75,3	55	0,3	31
	5.	120	84,4	0,5	55	105	73,2	52	0,4	52
	6.	135	83,5	0,6	75	120	70,8	49,8	0,8	72
	7. - nominal	155	82,5	0,8	106	140	68	47,1	1	101
	8. - boost	160	82,3	0,9	115	150	66,1	46	1,2	110

EFFICIENCY GRAPH
XFLAT-150- HRV

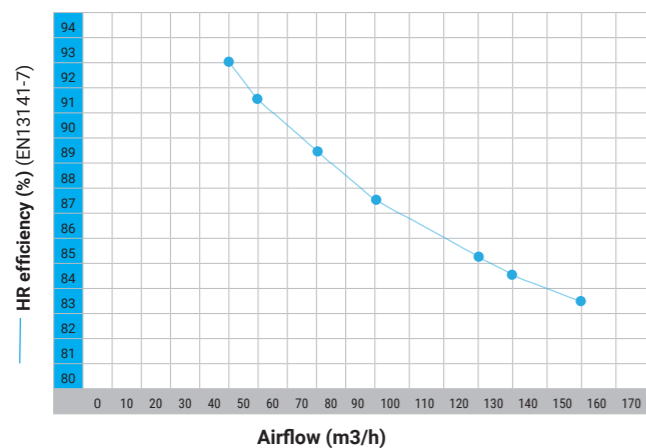

EFFICIENCY GRAPH
XFLAT-150- ERV

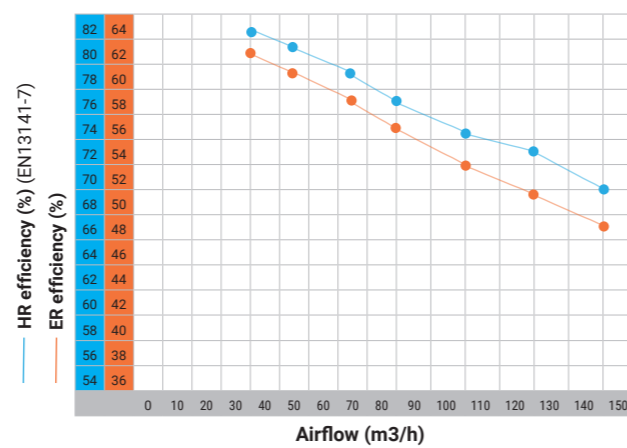

PERFORMANCE CHARACTERISTIC
XFLAT-150- HRV, ERV

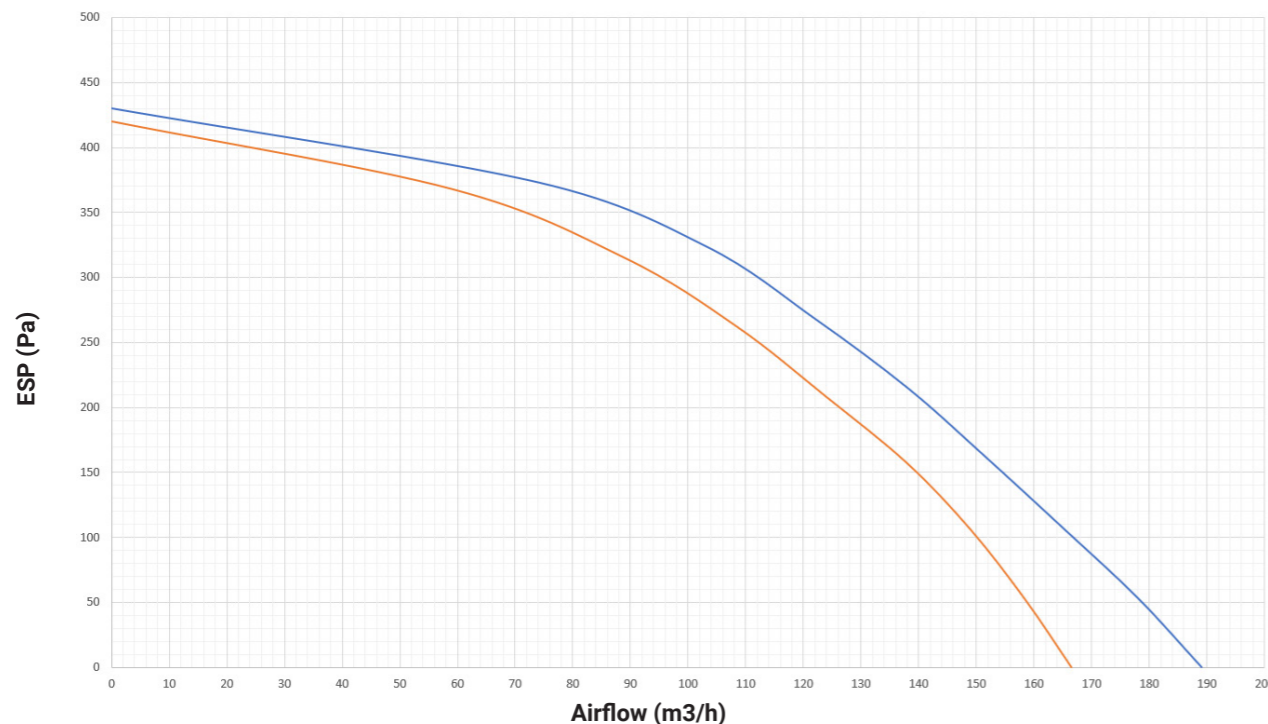

Technical parameters

Unit XFLAT		XF1-15-ECS0HRXAS-0A0	XF1-15-ECS0ERXAS-0A0
Type of recovery exchanger		HRV	ERV
Unit equipment *	preheater	electric (max.1kW external preheater)	electric (max.1kW external preheater)
Nominal airflow (external static pressure 150Pa)		m3/h	155
Noise level**		dB (A)	39,6
Weight***		kg	13
Power supply		V/Hz	1 ~ 230 / 50-60
Nominal power input		W	106
Recovery efficiency EN308	heat	%	85,1 / -
Protection		IP	20
Energy efficiency class (SEC)		-	cold climate A+ ; middle climate A ; warm climate E

* the preheater and after-heater are connected directly to the control of the unit and are controlled by its logic

** sound pressure level in (L_{pa}) 3m (Q2) - 135m3/h - 110Pa

*** unit weight (without packaging)



Data - ACOUSTICS

XFLAT 150

XF1-15-ECS0HRXAS-0A0 - radiating the unit into the interior (inside the room)									Sound power level LWA (dB A)	Sound pressure level in a free field on a reflecting plane	
Airflow - setting	63 Hz	125 Hz	250 Hz	500 Hz	1 kHz	2 kHz	4 kHz	8 kHz		LPA (dB) in 1,5m	LPA (dB) in 3m
35	17,4	20,5	25,4	28,9	29,1	22,0	15,5	10,9	33,6	<20	<20
50	17,7	30,9	35,0	35,9	33,9	25,8	16,3	11,0	40,5	21,7	<20
70	21,6	37,5	44,5	44,2	41,6	34,2	22,3	12,2	48,9	30,1	24,8
90	23,8	40,6	50,6	50,2	47,1	41,0	30,0	18,6	54,7	35,9	30,6
120	29,6	43,6	57,4	56,1	52,8	47,5	38,1	25,2	60,9	42,1	36,8
135	33,4	46,0	57,6	60,5	56,9	51,0	42,7	29,7	63,8	44,9	39,6
155	41,4	49,2	58,8	65,2	60,7	55,0	47,4	34,6	67,6	48,7	43,4
Boost *	41,8	52,8	62,3	71,5	66,1	60,6	53,7	41,3	73,3	54,5	49,2

XF1-15-ECS0ERXAS-0A0- radiating the unit into the interior (inside the room)									Sound power level LWA (dB A)	Sound pressure level in a free field on a reflecting plane	
Airflow - setting	63 Hz	125 Hz	250 Hz	500 Hz	1 kHz	2 kHz	4 kHz	8 kHz		LPA (dB) in 1,5m	LPA (dB) in 3m
30	15,8	19,8	25,2	28,0	28,3	21,3	14,5	9,9	32,9	<20	<20
45	16,1	30,2	34,7	35,0	33,2	25,0	15,4	10,0	39,7	20,9	<20
65	20,0	36,8	44,3	43,3	40,8	33,5	21,3	11,2	48,2	29,3	24,0
80	22,2	40,0	50,4	49,3	46,4	40,2	29,0	17,6	54,0	35,1	29,8
105	28,0	43,0	57,2	55,2	52,1	46,7	37,2	24,2	60,2	41,3	36,0
120	31,8	45,3	57,3	59,6	56,2	50,2	41,7	28,7	63,0	44,1	38,8
140	39,8	48,6	58,5	64,2	60,0	54,2	46,4	33,6	66,8	47,9	42,6
Boost *	40,2	52,2	62,0	70,5	65,4	59,8	52,8	40,3	72,5	53,74	48,44

XF1-15-ECS0HRXAS-0A0 - radiating the unit into the duct									Sound power level LWA (dB A)
Airflow - setting	63 Hz	125 Hz	250 Hz	500 Hz	1 kHz	2 kHz	4 kHz	8 kHz	
ODA	51,0	62,6	61,2	60,7	58,6	48,1	43,7	30,1	67,2
SUP	43,2	53,5	55,4	61,1	53,4	50,0	38,0	21,3	63,4
ETA	48,7	59,4	55,5	59,6	53,0	48,2	38,7	27,4	63,9
EHA	44,1	53,5	54,6	61,2	52,6	49,8	38,0	24,0	63,3

Packaging and dimensions

XFLAT 150	Type	Coding	Weight		Package size (width x length x height)	Pieces on a pallet (max.stackability)
			Brutto	Netto		
			kg		m	
XFLAT UNIT	XF1-15-ECS0HRXAS-0A0	XF1-15-ECS0ERXAS-0A0	15	13	0,97x0,68x0,24	9
			15,5	13,5		

Package includes:

- Unit Xflat
- Quick manual
- Safety instruction

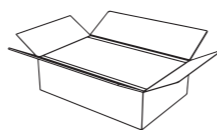

Basic dimensions

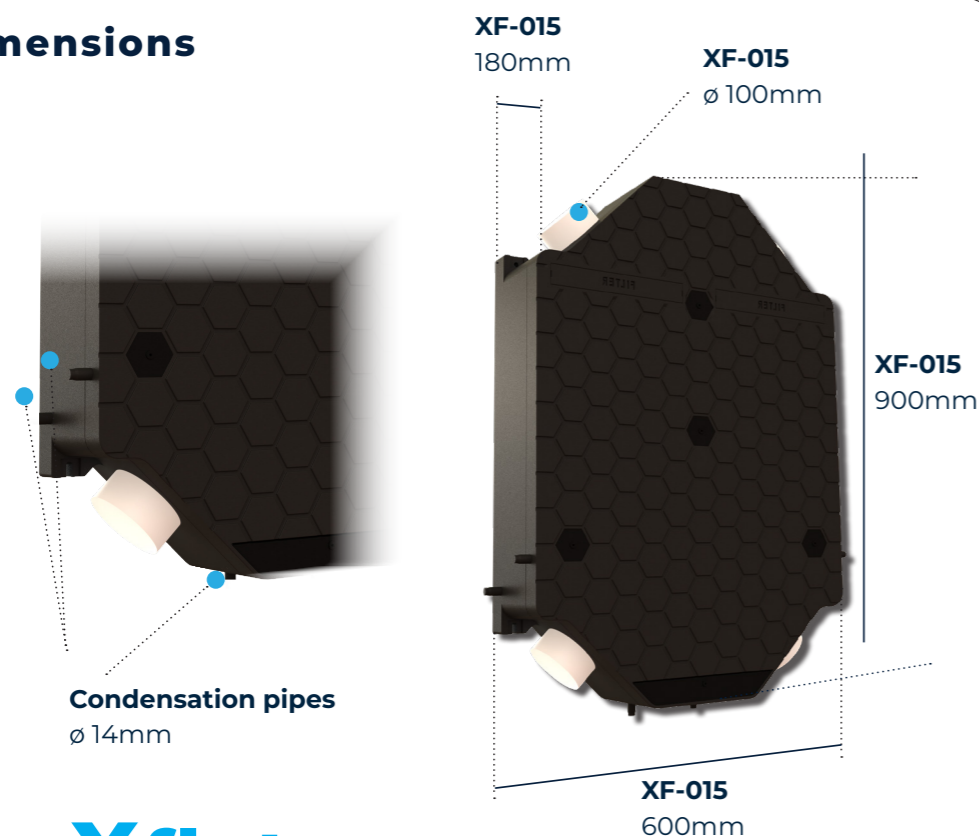

Instalation Xflat

The Xflat unit allows installation on both the wall (horizontally, vertically) and the ceiling. Fastening is done with self-tapping screws and washers into the prepared holes in the EPP body. Subsequently, it is only necessary to cut off the relevant condensate drain during installation and connect the hose.

WALL VERTICAL INSTALLATION (control up)

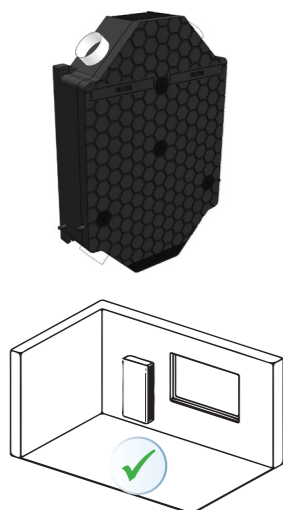

WALL HORIZONTAL INSTALLATION (Only version with enthalpy exchanger)

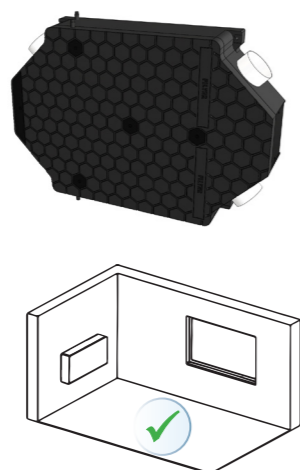

CEILING INSTALLATION

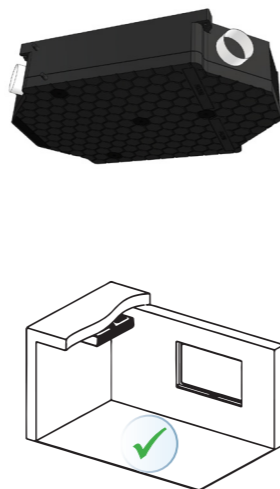

Accessories

Filters Xroom



M5 - Coarse 90% ISO 16890	F7 - ePM1 50 % ISO 16890
XF-015-FILTER-M5	XF-015-FILTER-F7

CO₂ room sensor



CO2 sensor
NL-ECO-CO2

CO2 room sensor - after switching the unit to automatic mode, the air flow is regulated based on the CO2 concentration in the room.

Rh room sensor



RH sensor
NL-ECO-RH

RH room sensor - after switching the unit to automatic mode, the air flow is regulated based on the concentration of relative humidity in the room.

CO₂+RH sensor



RH sensor
NLII-CO2+RH

CO₂+RH room sensor - after switching the unit to automatic mode, the air flow is regulated based on the concentration of relative humidity in the room.

ModbusBox



ModBus box
XCONT-HUB

ModbusBox - extension control module for connection to a superior unit control system. (Modbus).

AQS extension



AQA extension
PRO-SUM-08

AQS extension - allows to connect up to 8 pcs of air quality sensors



Installation and service manual on our website



more information



Xvent s.r.o.
Poděbradská 289,
53009 Pardubice
Czech Republic

+420 467 070 233
office@xvent.cz

www.xvent.cz